

Vg1



Frank Fosbæk

Automatisering

Vg1 elektrofag

ELFORLAGET

Illustrasjoner til Automatisering Vg1 elektrofag







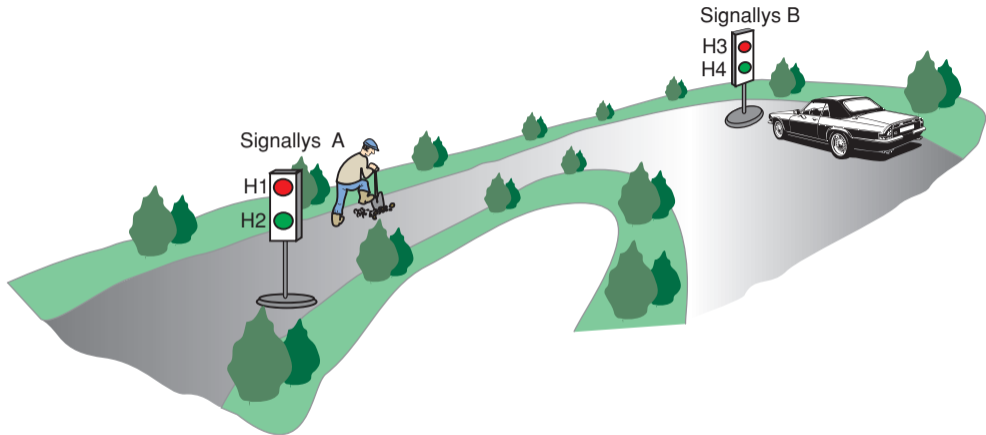









Kapittel 16

Illustrasjonene kan brukes fritt i undervisningen

© Elforlaget 2013



Figur 16.1 Prinsippskisse av lyssignalanlegget

	Signallys A		Signallys B		Tid i sek.
	H1 rødt	H2 grønt	H3 rødt	H4 grønt	
Trinn 1					5
Trinn 2					10
Trinn 3					5
Trinn 4					10
Trinn 1	Som trinn 1				

Figur 16.2 Funksjonstabell for lysanlegget

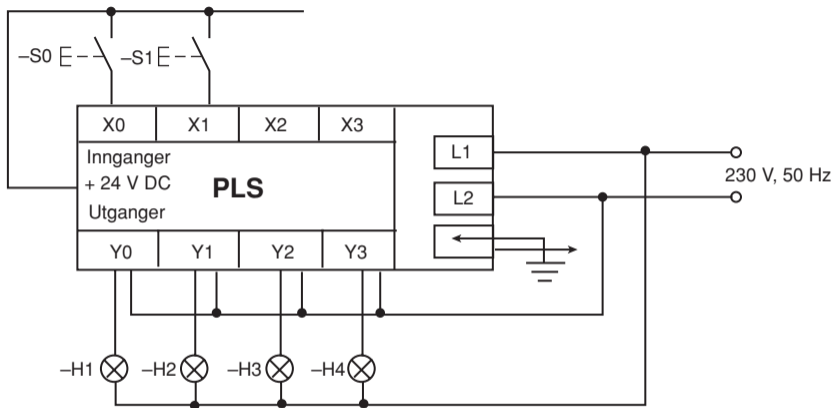

Figur 16.3 Koblingskjema for styring av lyssignalanlegget

Symbol	I/O-variabel Operand	Kommentar
S0	X0	Startbryter, trykknappbryter med sluttekontakt
S1	X1	Stoppbryter, trykknappbryter med sluttekontakt
H1	Y0	Signallys A, lampe H1, Rød , 230 V
H2	Y1	Signallys A, lampe H2, Grønn, 230 V
H3	Y2	Signallys B, lampe H3, Rød, 230 V
H4	Y3	Signallys B, lampe H4, Grønn,230 V

Figur 16.4 Tilordningsliste

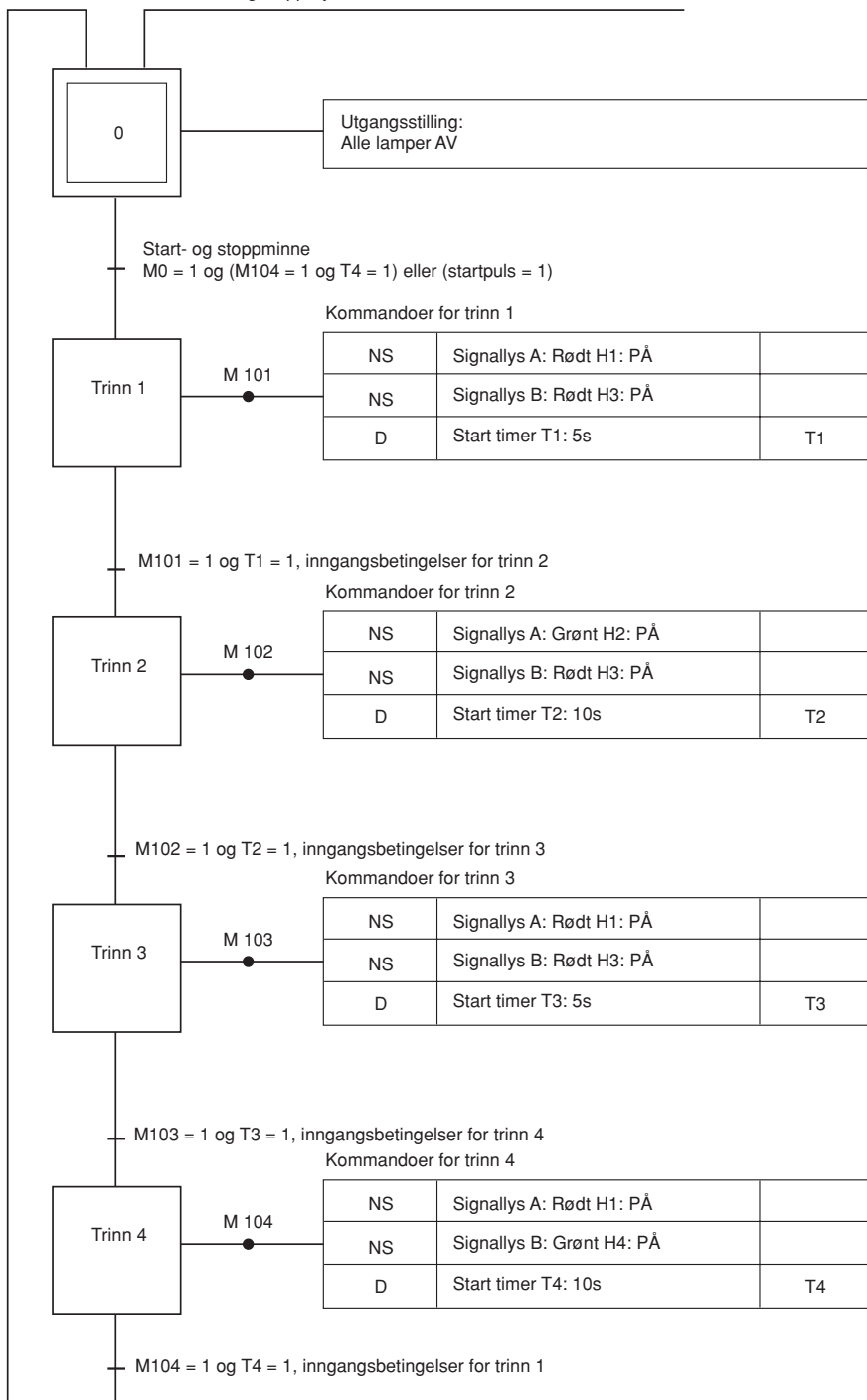

Figur 16.5 Sekvensielt funksjonsdiagram for lyssignalanlegget

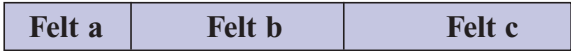

Figur 16.6 Kommandosymbol

Bokstavkode	Engelsk betydning	Norsk betydning
NS	Not stored	Ikke husket
S	Stored (SET)	Husket
D	Not stored but delayed	Ikke husket, men tidsforsinket
L	Not stored but time limited	Ikke husket, men tidsbegrenset
SD	Stored and delayed	Husket og forsinket
DS	Delayed and stored	Forsinket og husket
SL	Stored and time limited	Husket og tidsbegrenset
C	Conditional action	Aksjon under visse betingelser
SC	Stored and conditional action	Husket under visse betingelser
CS	Conditional and stored action	Betinget og husket
R	Overriding Reset	Overordnet Reset

Figur 16.7 Liste over bokstavkoder for ulike typer kommandoer

NS	Signallys A: Rødt, H1 PÅ	
NS	Signallys B: Rødt, H3 PÅ	
D	Tidsforsinkelse 5 s. Start timer T1	T1

Figur 16.8 Kommandoer (handlinger) for trinn 1

Startbryter (sluttekontakt) er koblet til inngang: X0
 Stoppbryter (sluttekontakt) er koblet til inngang: X1

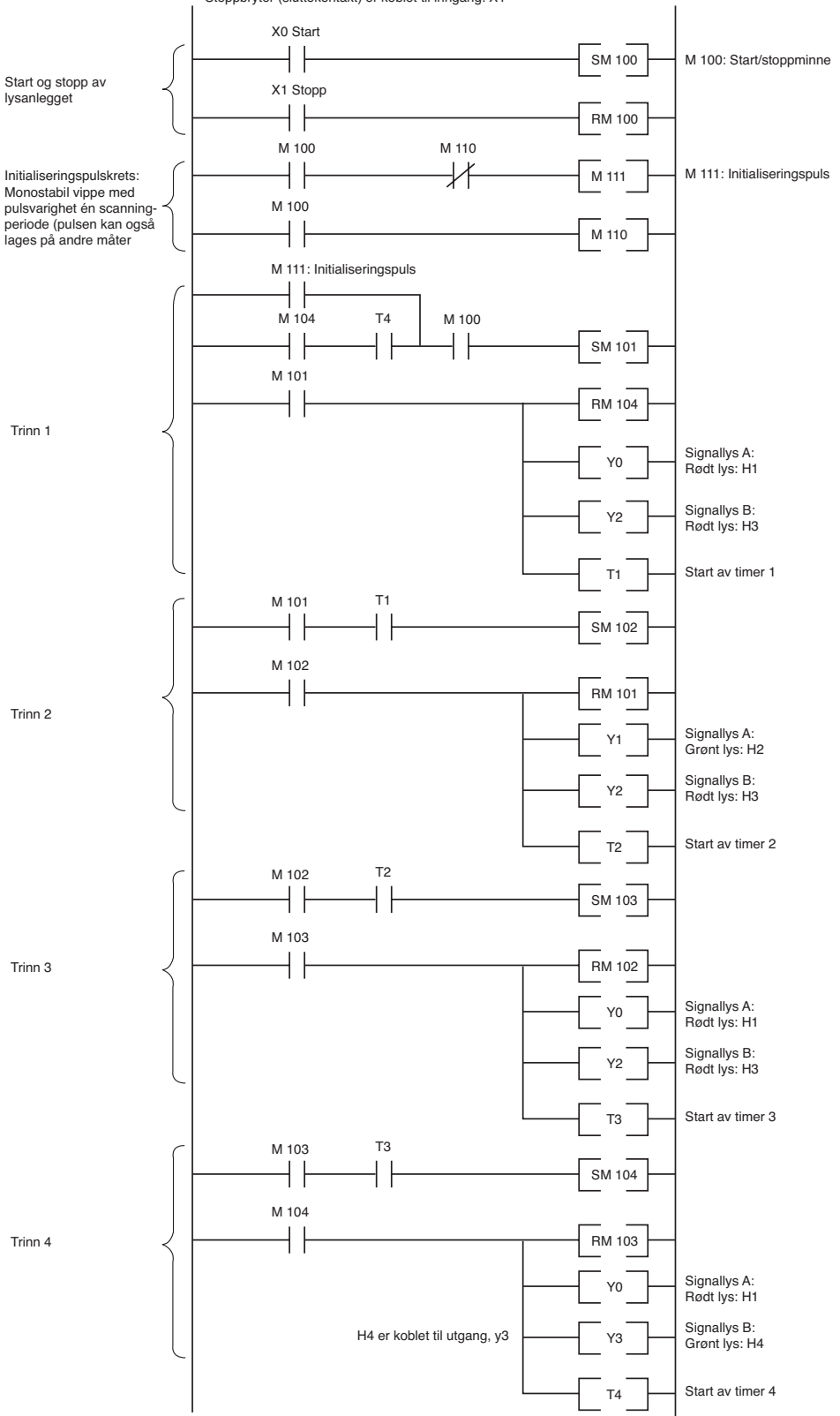

Figur 16.9 Ladderdiagram