

Vg1

Fosbæk, Vangsnes, Venås

# Data og kommunikasjon

Vg1 elektrofag

*ELFORLAGET*

# Illustrasjoner til Data og kommunikasjon Vg1 elektrofag

## Kapittel 2

Illustrasjonene kan brukes fritt i undervisningen

©Elforlaget 2009



Figur 2.1  
Ringelegg

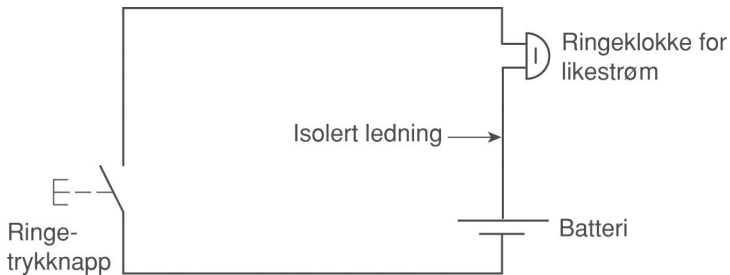

*Figur 2.2*  
*Strømkrets for likestrømsringeanlegg*

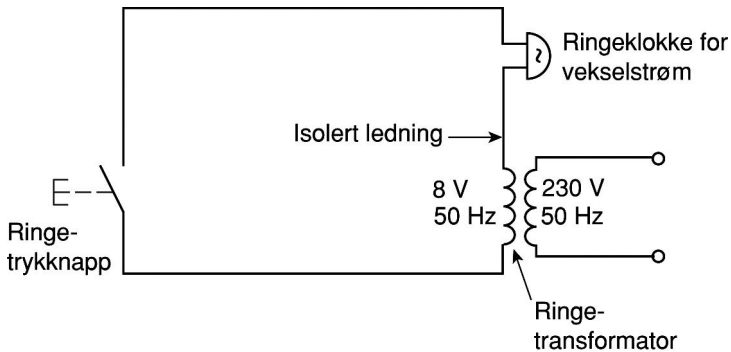

*Figur 2.3*  
*Strømkrets for vekselstrømsringeanlegg*

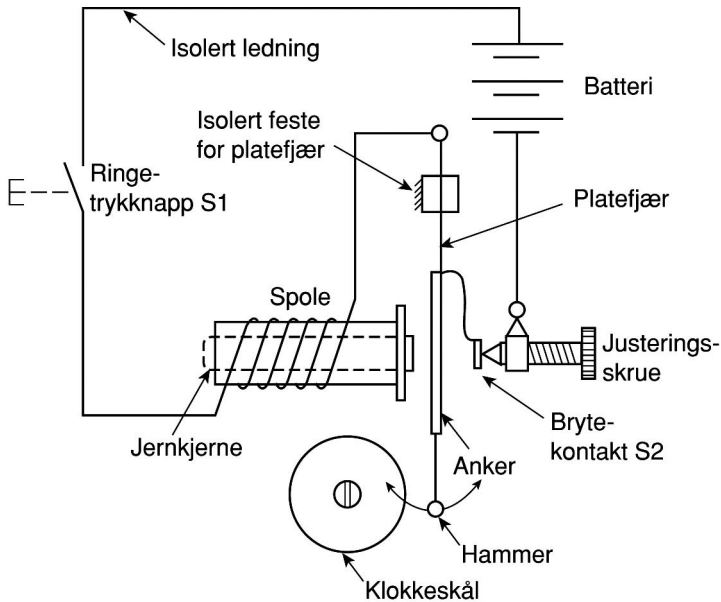

*Figur 2.4*  
*Prinsippskisse for et ringeanlegg for likestrøm*

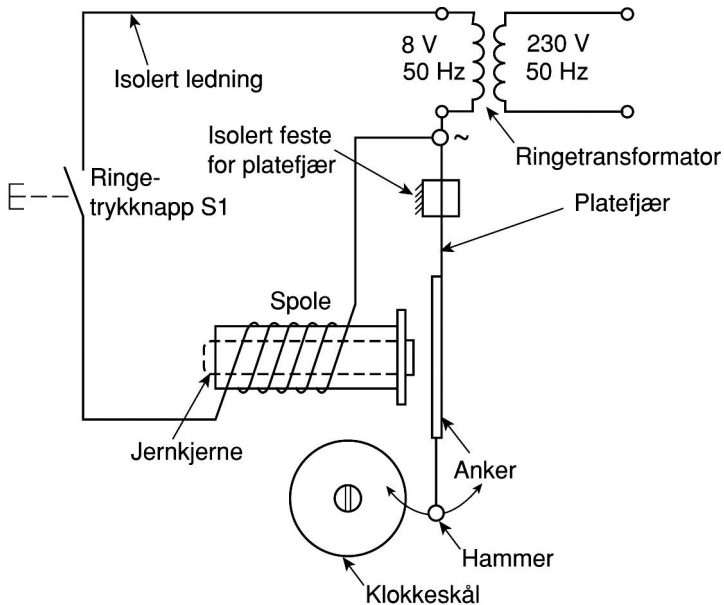

*Figur 2.5*  
*Prinsippskisse for et ringeanlegg for vekselstrøm*

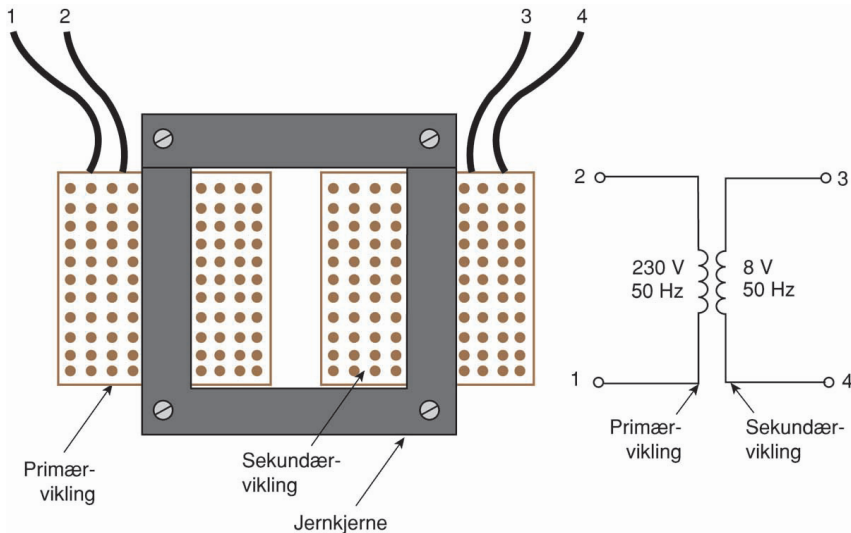

*Figur 2.6*  
*Skisse og koblingsskjema for en ringtransformator*



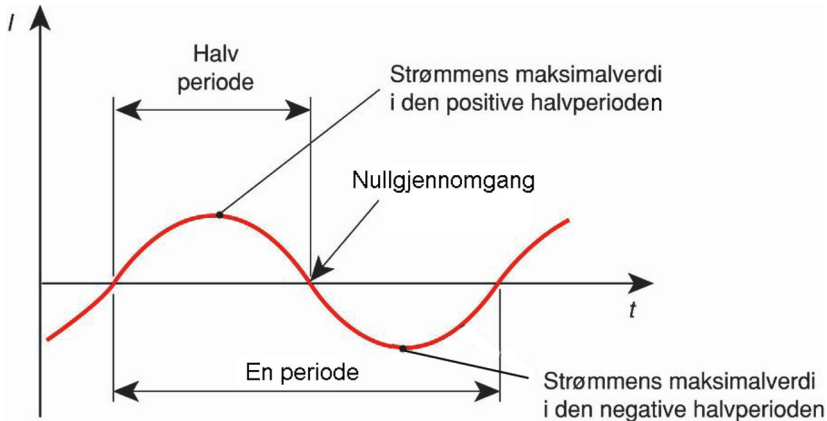

*Figur 2.7*  
*Sinusformet vekselstrøm*

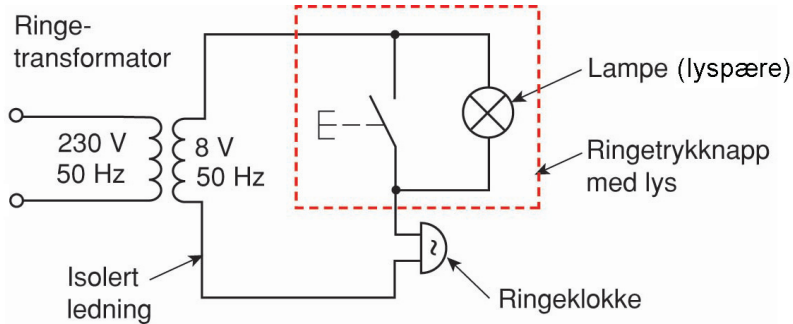

*Figur 2.8*  
*Koblingsskjema for ringetrykknapp med belysning*



*Figur 2.9*  
*Ringetrykknapper*

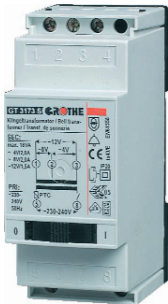

*Figur 2.10*  
*Ringtransformator*

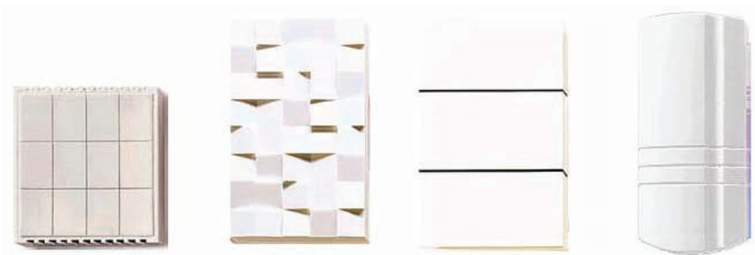

*Figur 2.11  
Noen ulike typer  
klangklokker*

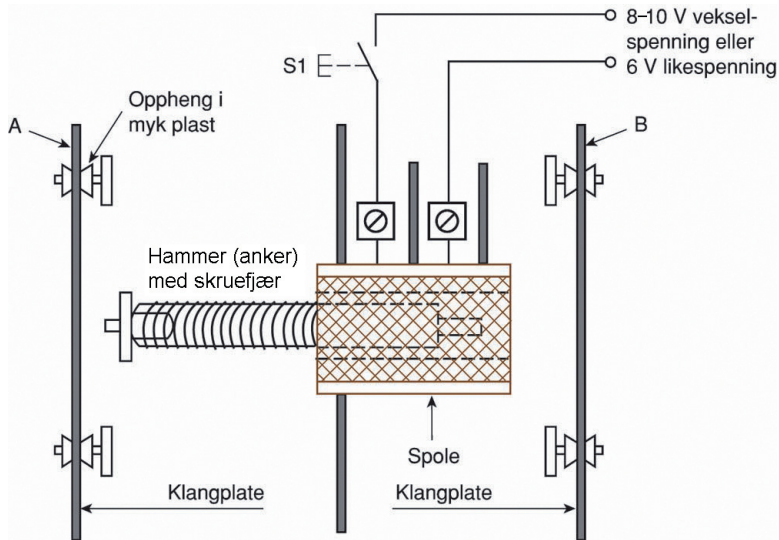

*Figur 2.12*  
*Klangklokke med to klangplater*

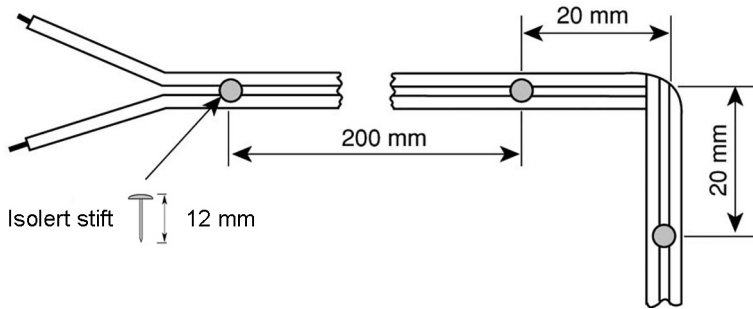

*Figur 2.13*  
*Festing av ringeledning*

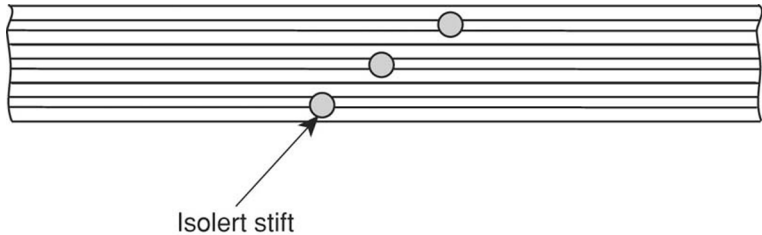





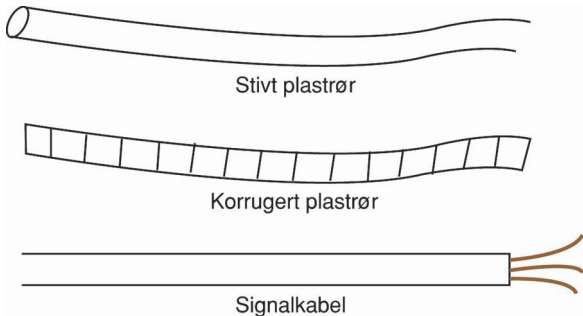











*Figur 2.14*  
*Festing av flere ringeledninger*



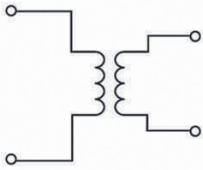

*Figur 2.15*  
*Plastrør og signalkabel*

Utstyr (materiell)	Symboler for flerlinjeskjema	Symboler for enlinjeskjema
Ringeklokke 	Likestrømsklokke  Vekselstrømsklokke 	 
Ringetrykknapp 	 Sluttekontakt med automatisk tilbakestilling	  Med indikasjonslampe
Batteri 		
Sikringer 	 	 Symbol for to sikringer
Ringe- transformator 		

Figur 2.16  
 Elektrotekniske symboler for ringeanlegg

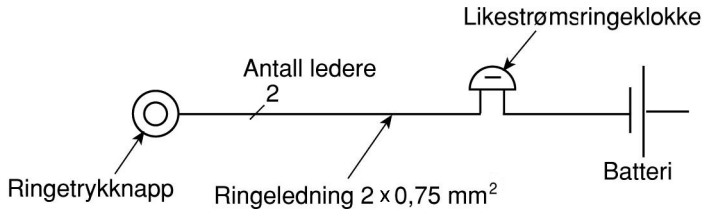

*Figur 2.17*

*Enlinjeskjema for enkelt ringeanlegg*

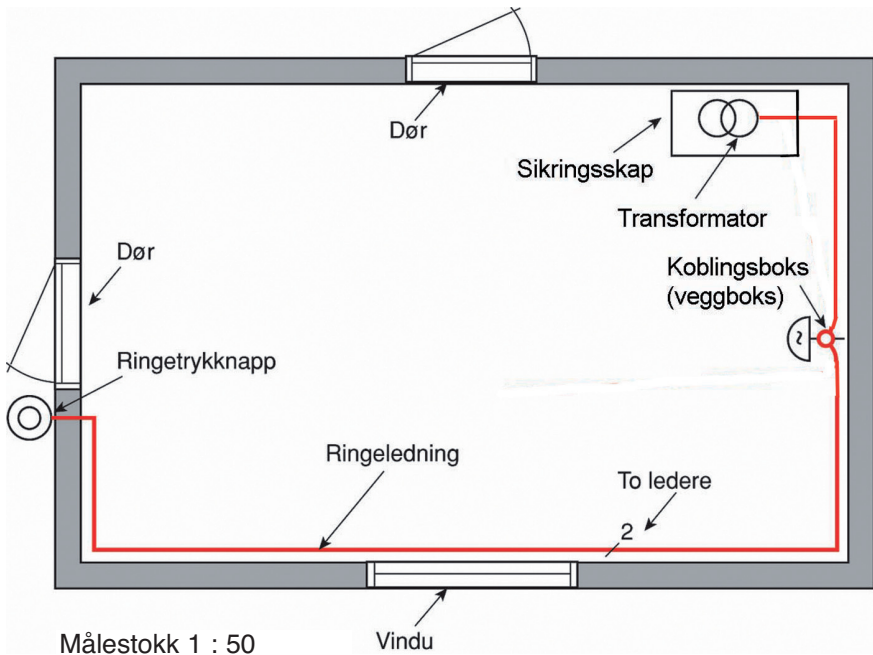

*Figur 2.18*

*Installasjonstegning for ringeanlegg, åpen installasjon*

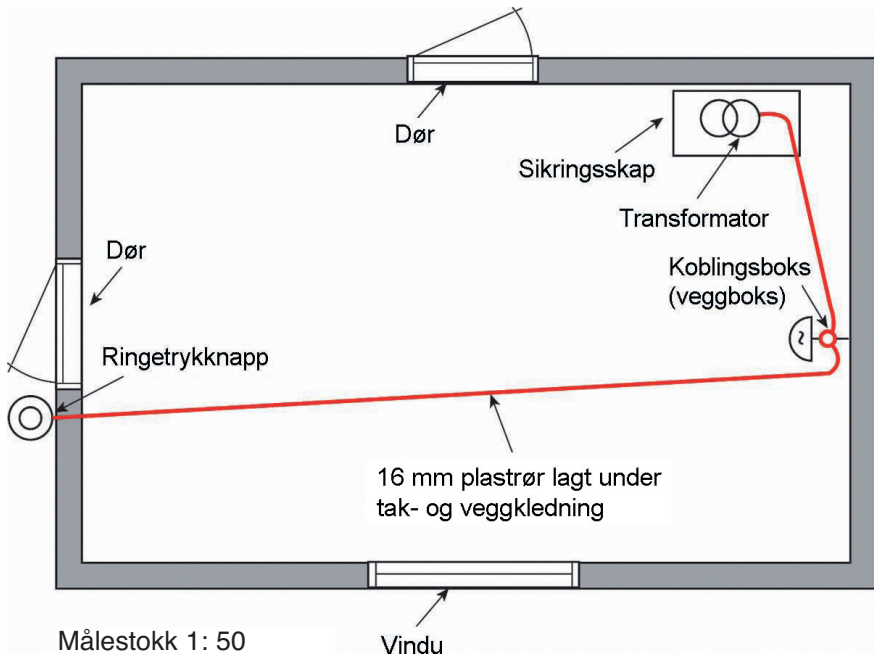

Figur 2.19

Installasjonstegning for ringeanlegg, skjult installasjon

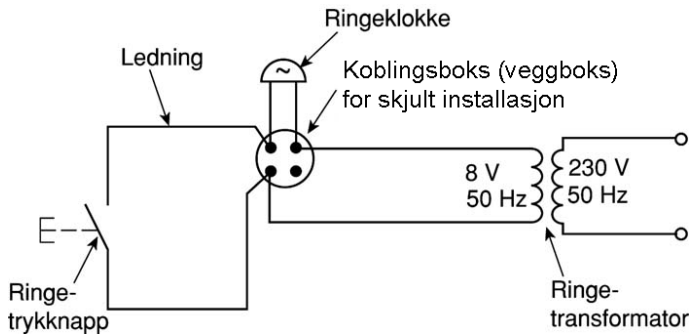

*Figur 2.20*  
*Koblingsskjema*



*Figur 2.21 Trådløst ringeanlegg  
(kilde: Clasohlsson.no)*

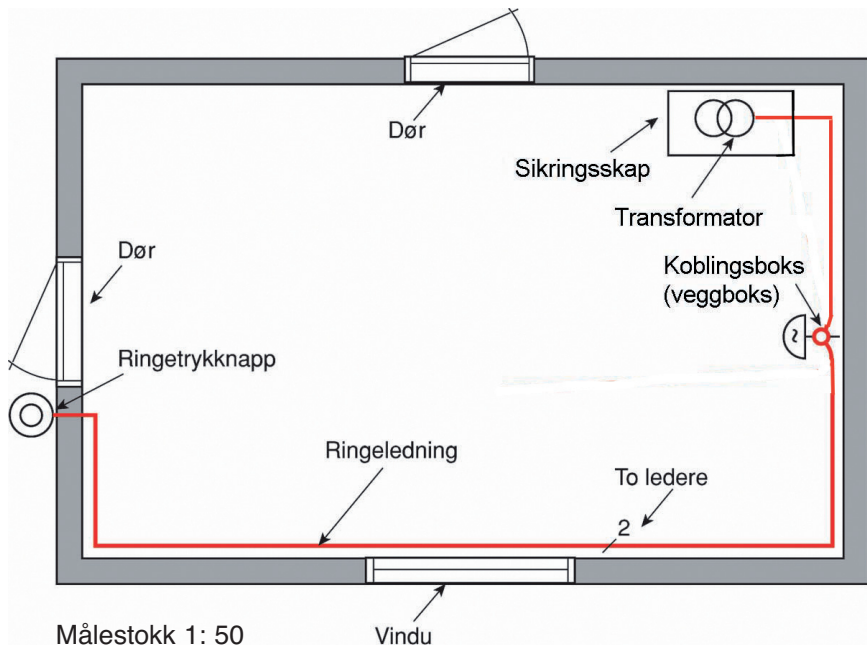

*Figur 2.22*  
*Åpen installasjon*



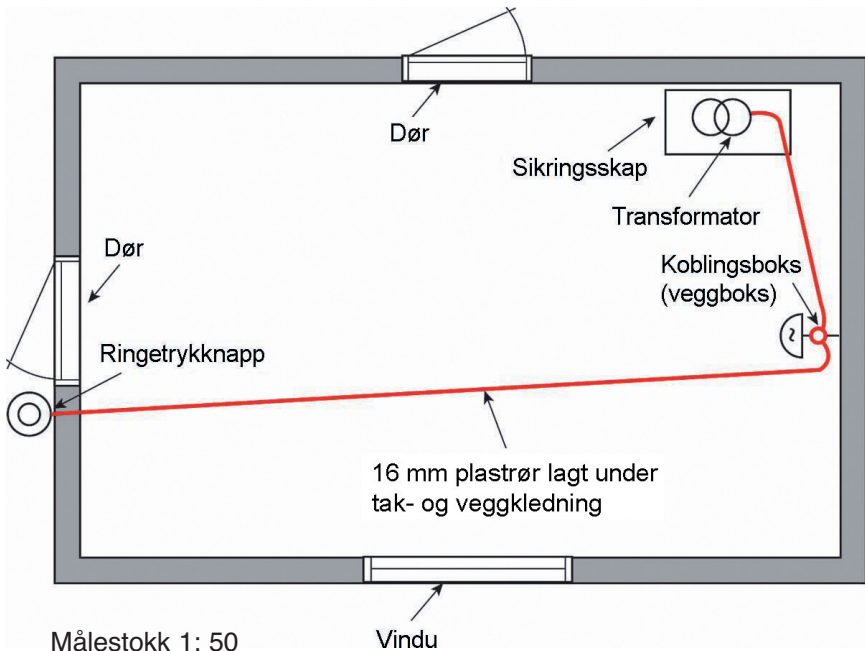

*Figur 2.23*  
*Skjult installasjon*

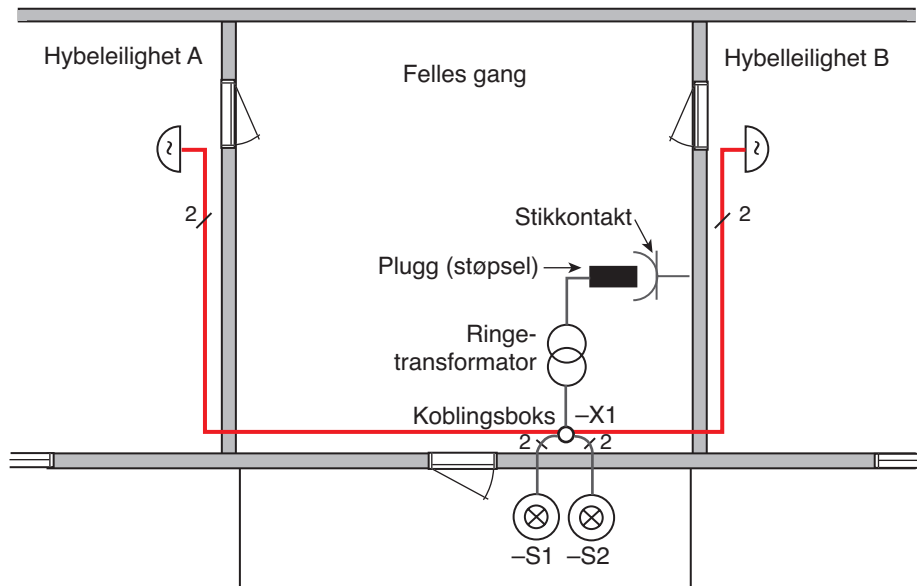

Figur 2.24  
 Installasjonstegning for ringeanlegget

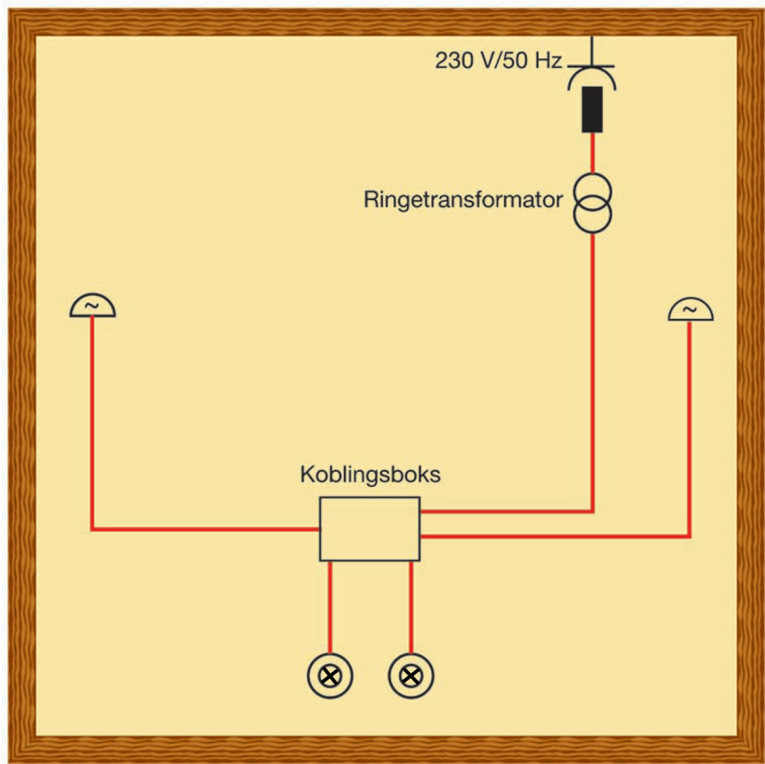

Figur 2.25



*Figur 2.26*  
*Trykknapptablå*  
*for installasjonen*

X1 – X4 er  
betegnelsen  
på koblings-  
boksene

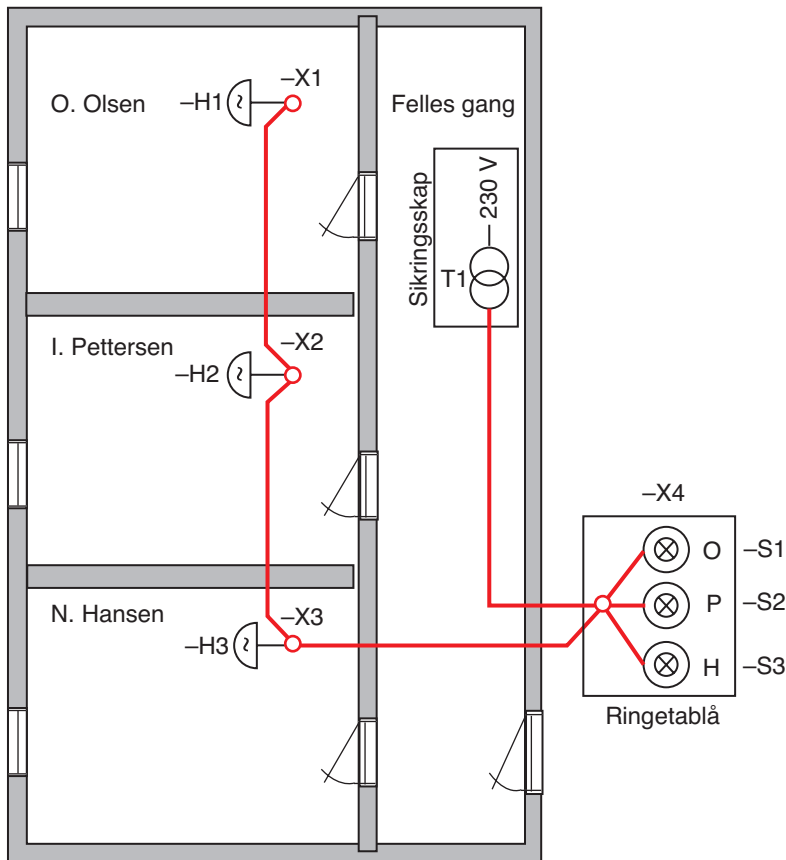

Målestokk 1 : 100

Figur 2.27 Installasjonstegning for ringeanlegget

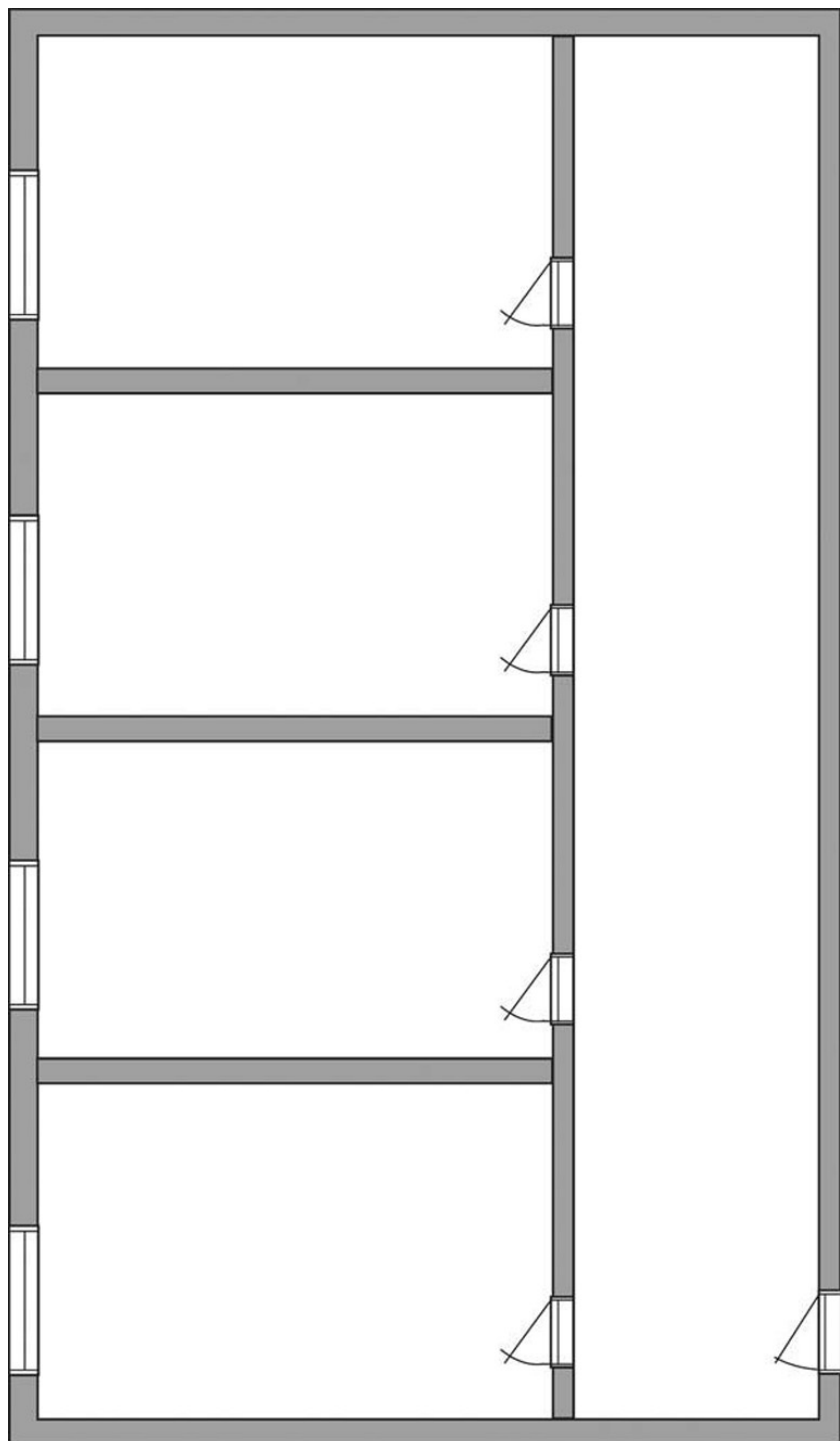

Målestokk 1 : 100

*Figur 2.28*