



Elektronlaget





Efforlaget





Elforlaget



Elforlaget



Kappe

Skjerm



Elforlaget



Elförlaget







Elförlaget









Elförlaget





Efforlaget



Elforlaget

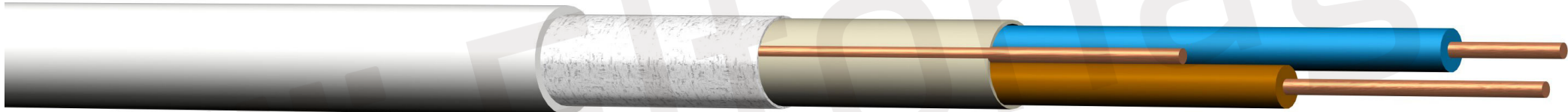





COAXIAL ICT Nexans

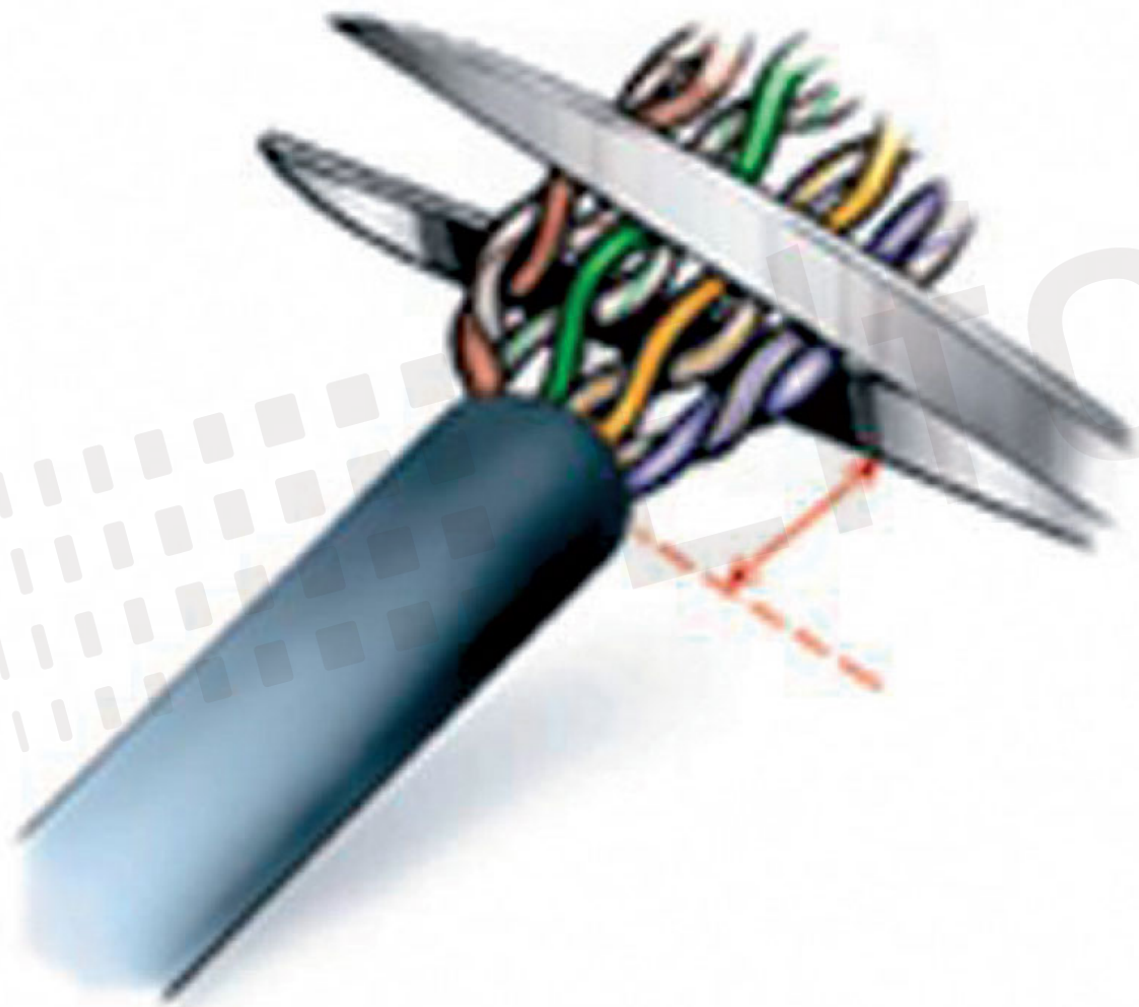









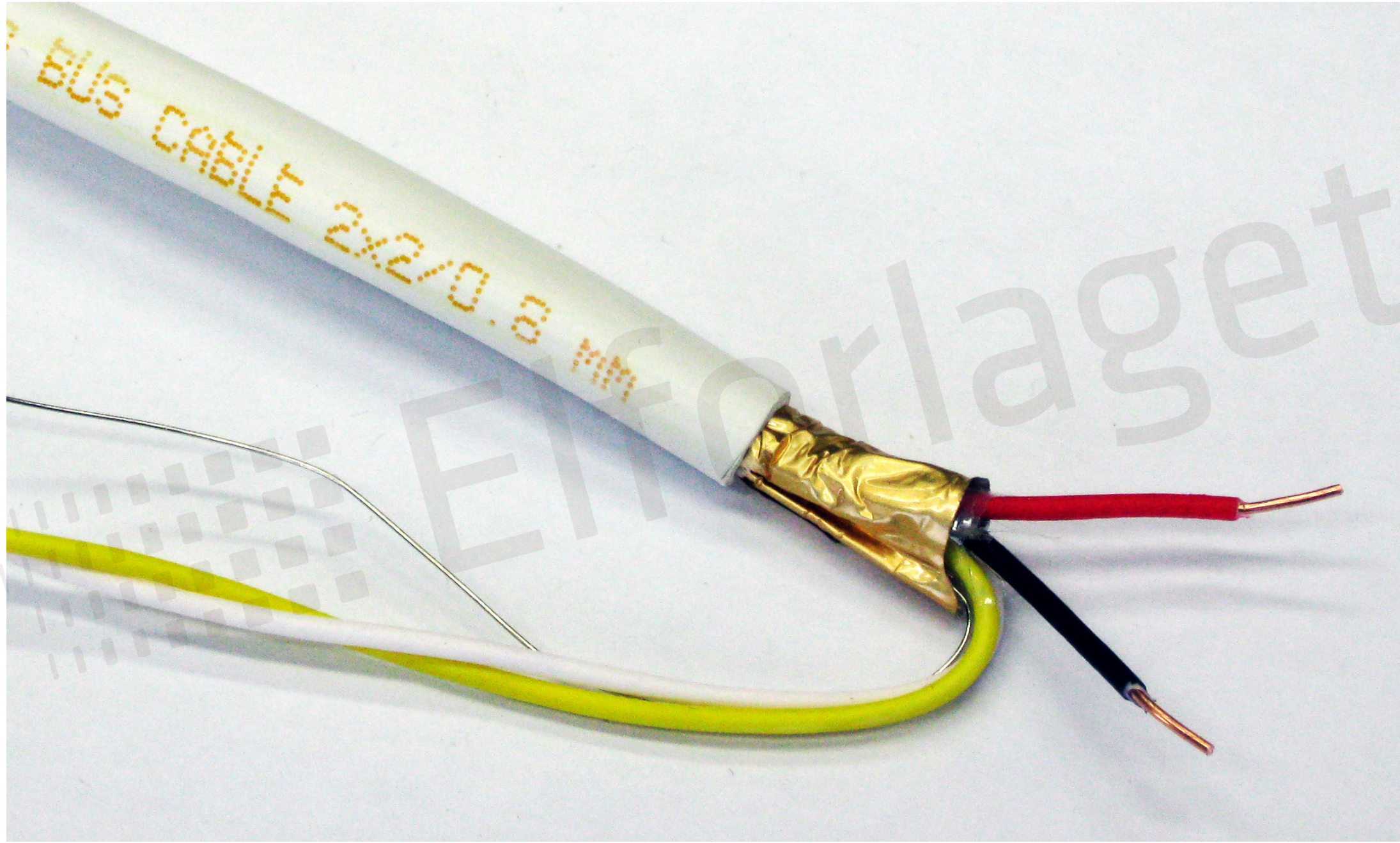







asset

















**TELE / DATA**



Effortless get







KA



1000 V EN/IEC 60900 : 20

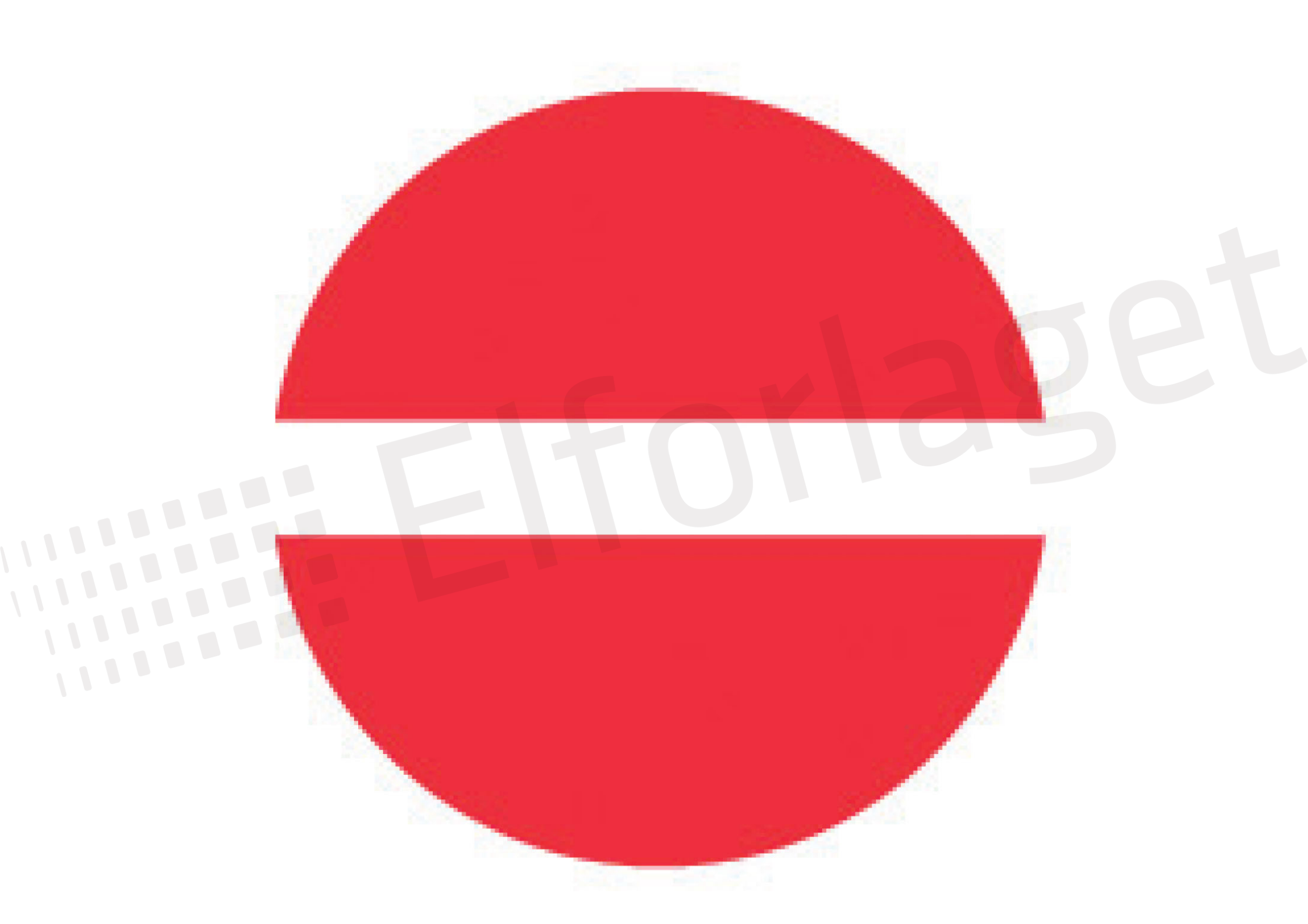

Elforlaget

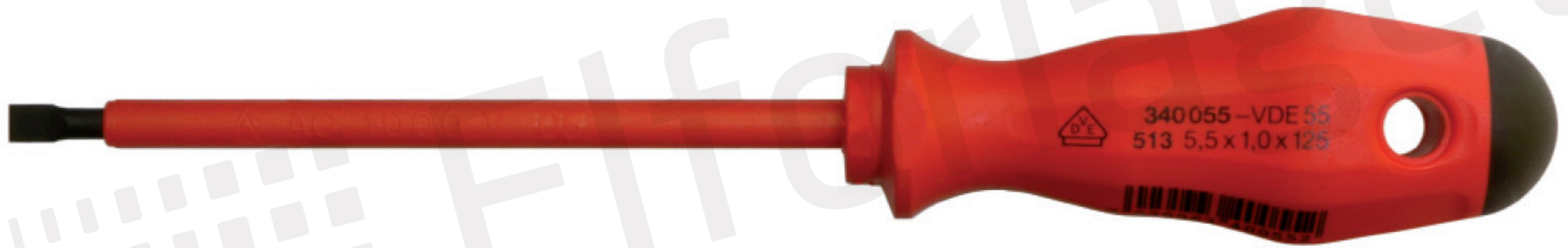

340055 - VDE 55  
513 5,5 x 1,0 x 125





Elforlaget





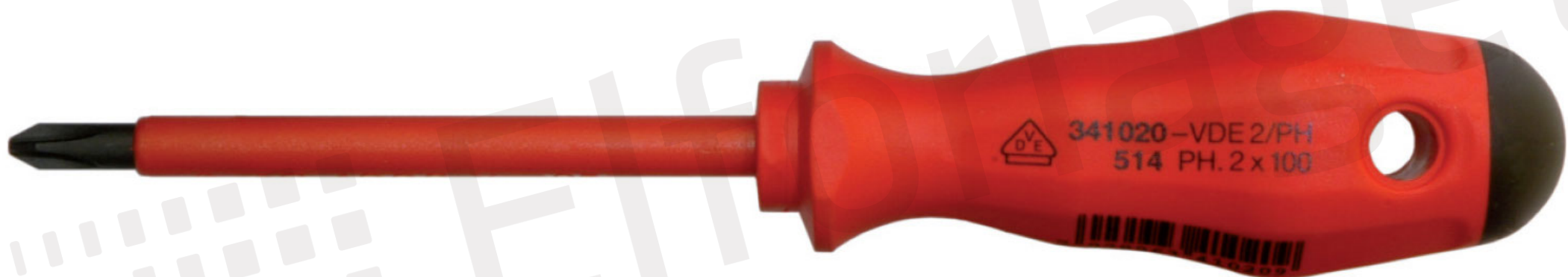

341020 - VDE 2/PH  
514 PH. 2 x 100





Eiforlaget



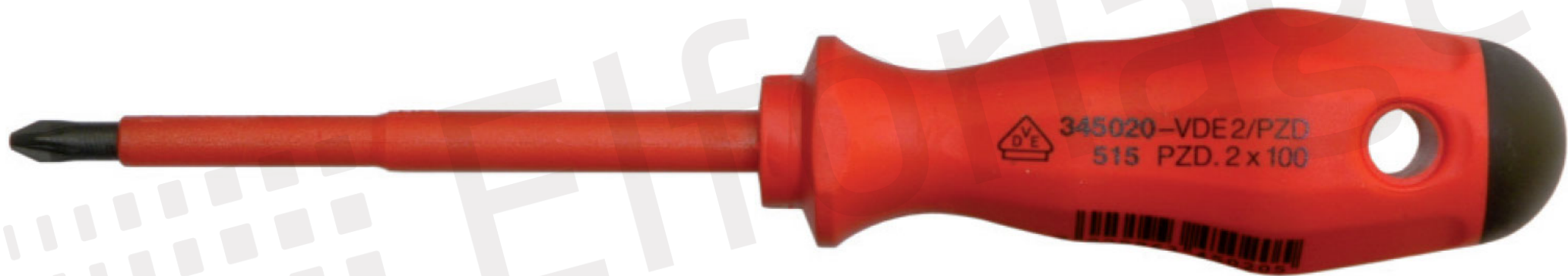

345020-VDE2/PZD  
515 PZD. 2x100







GEILO

GEILO - NO:WAY



**LETTI 8**  
Lettiverktøy

El nr. 13 176 11



www.letti.no

**LETTI**  
-montørens førstevalg

TOOLmaget











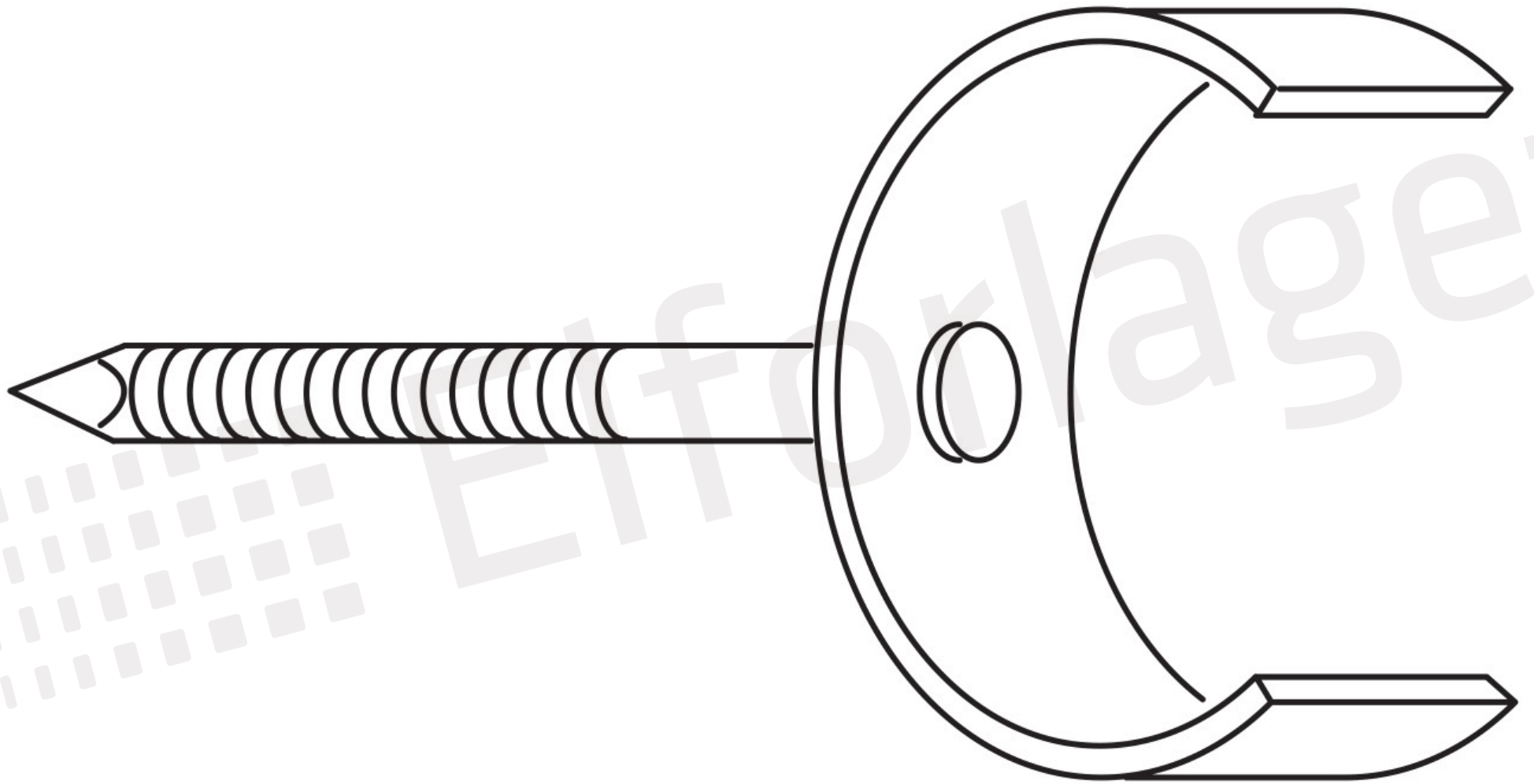

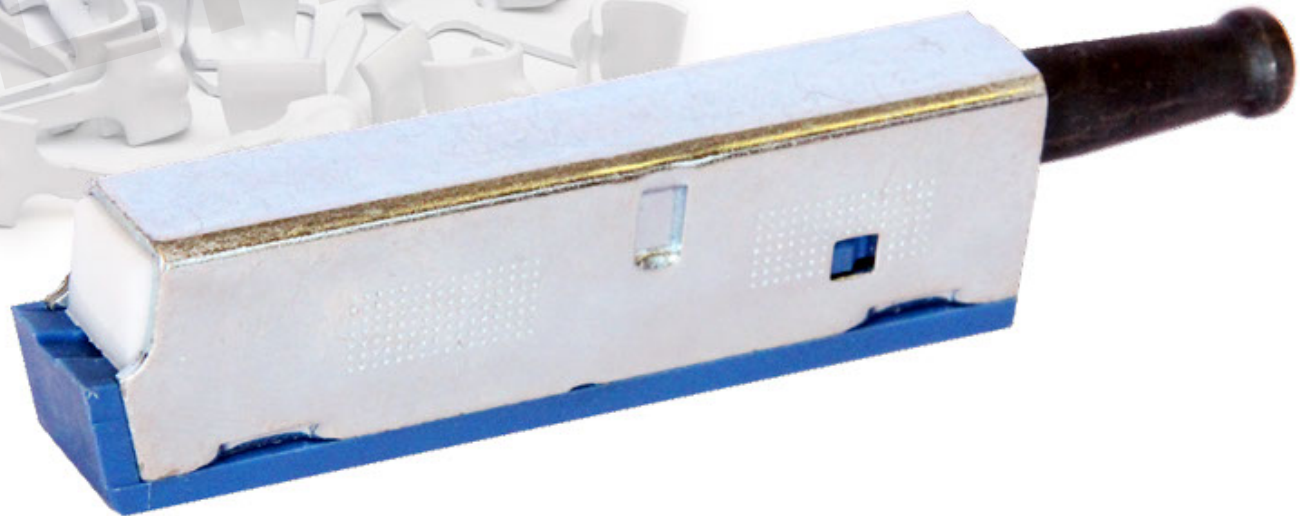

klammet





E forlaget



Elforlaget









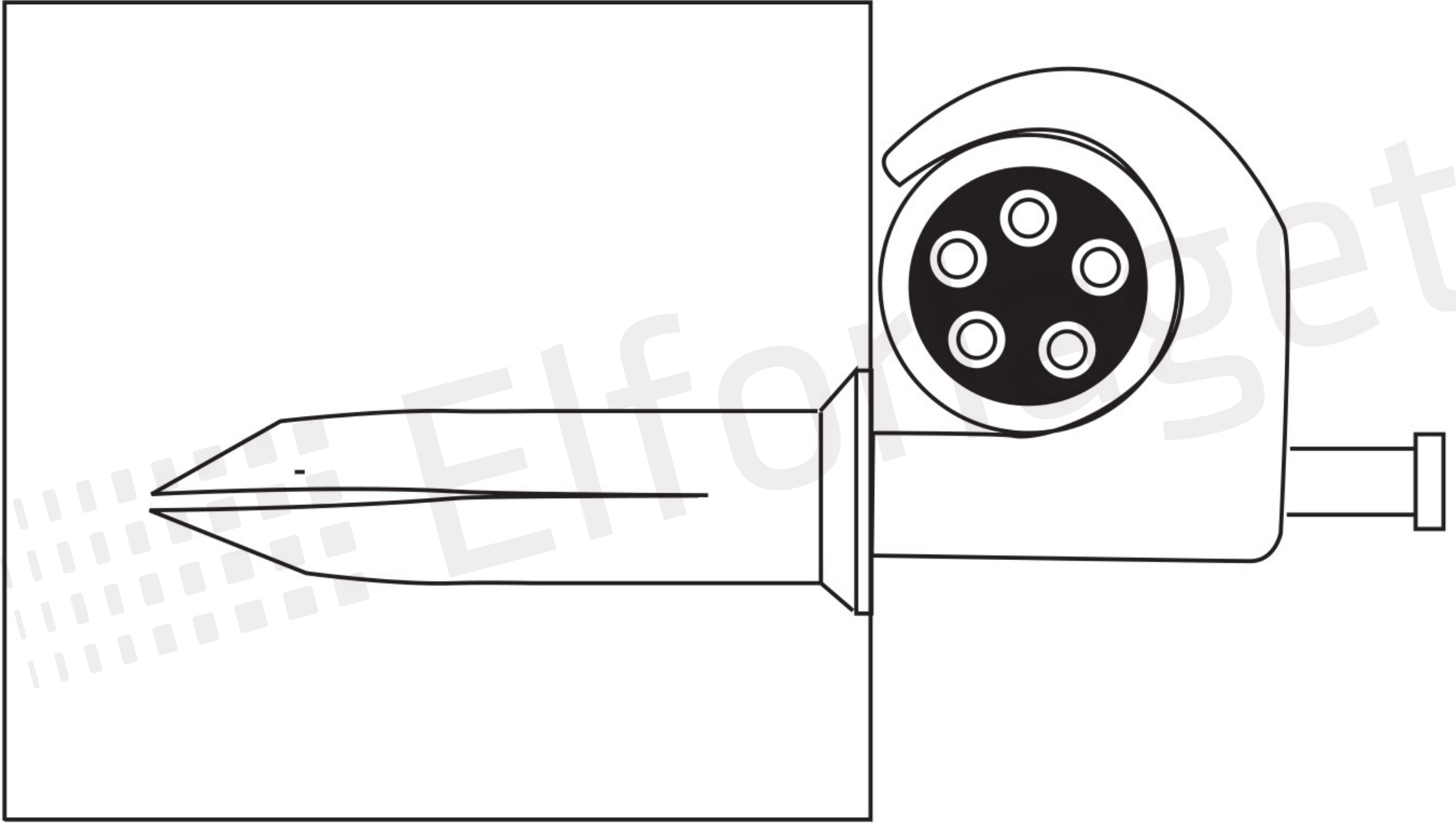

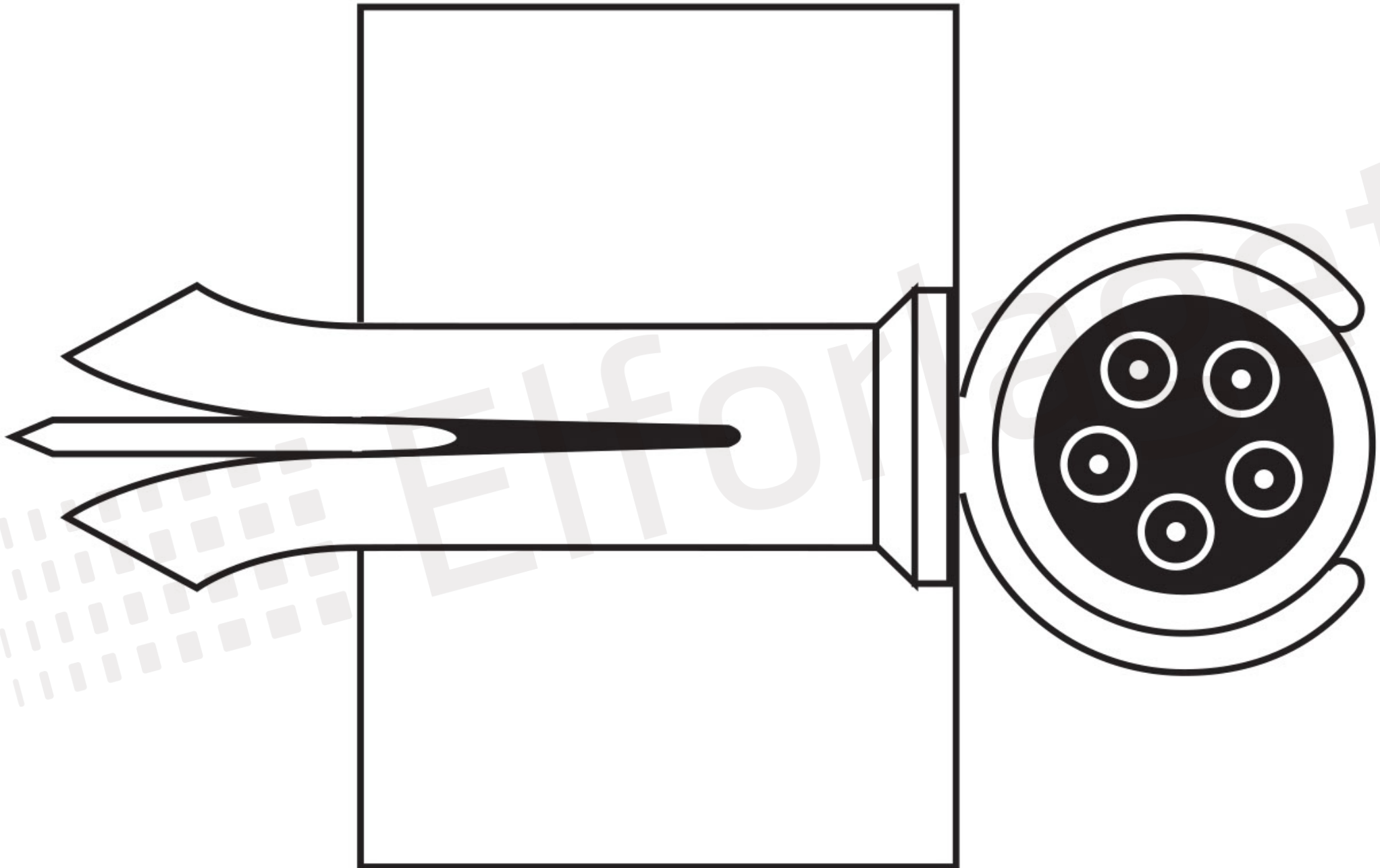

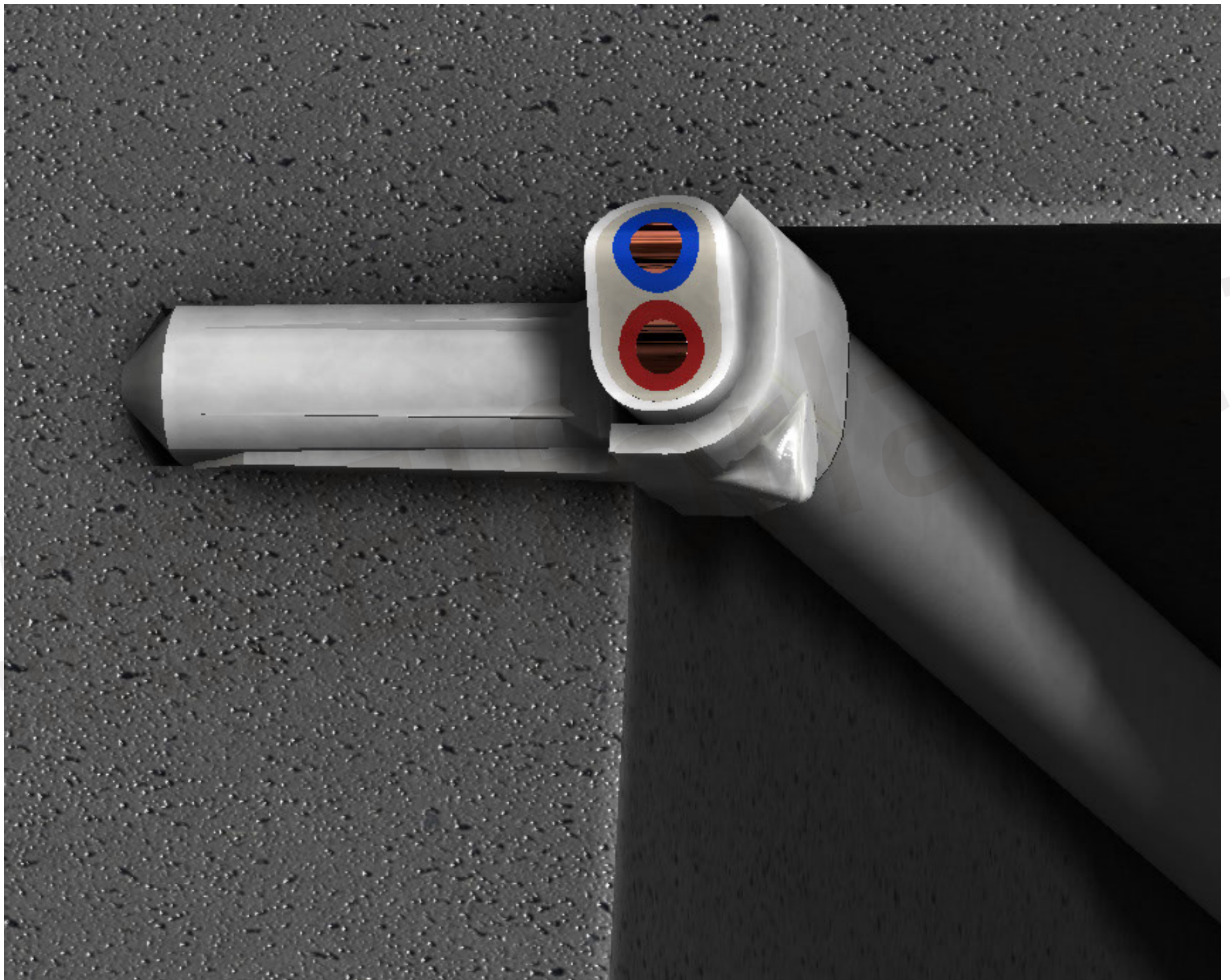

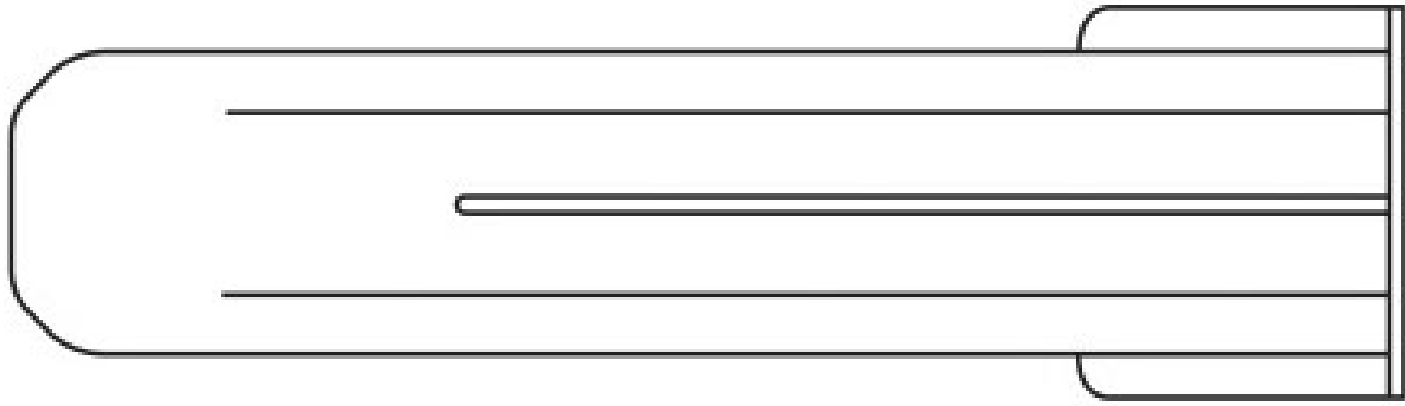

Elforlaget

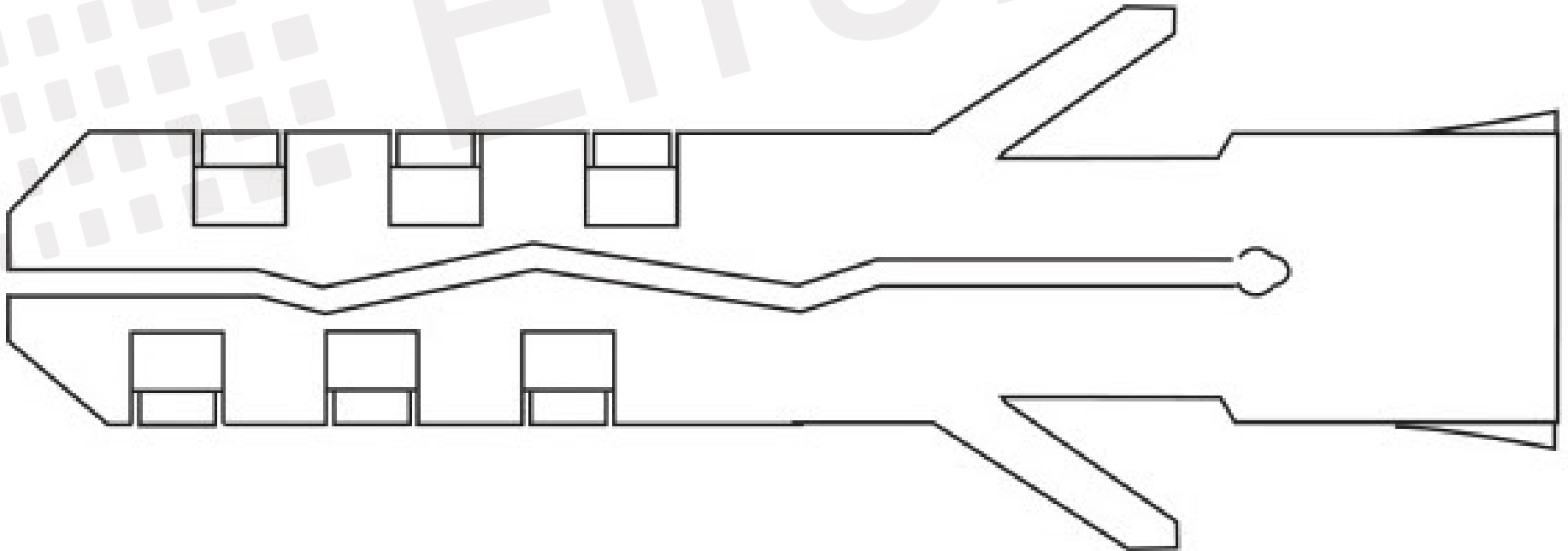



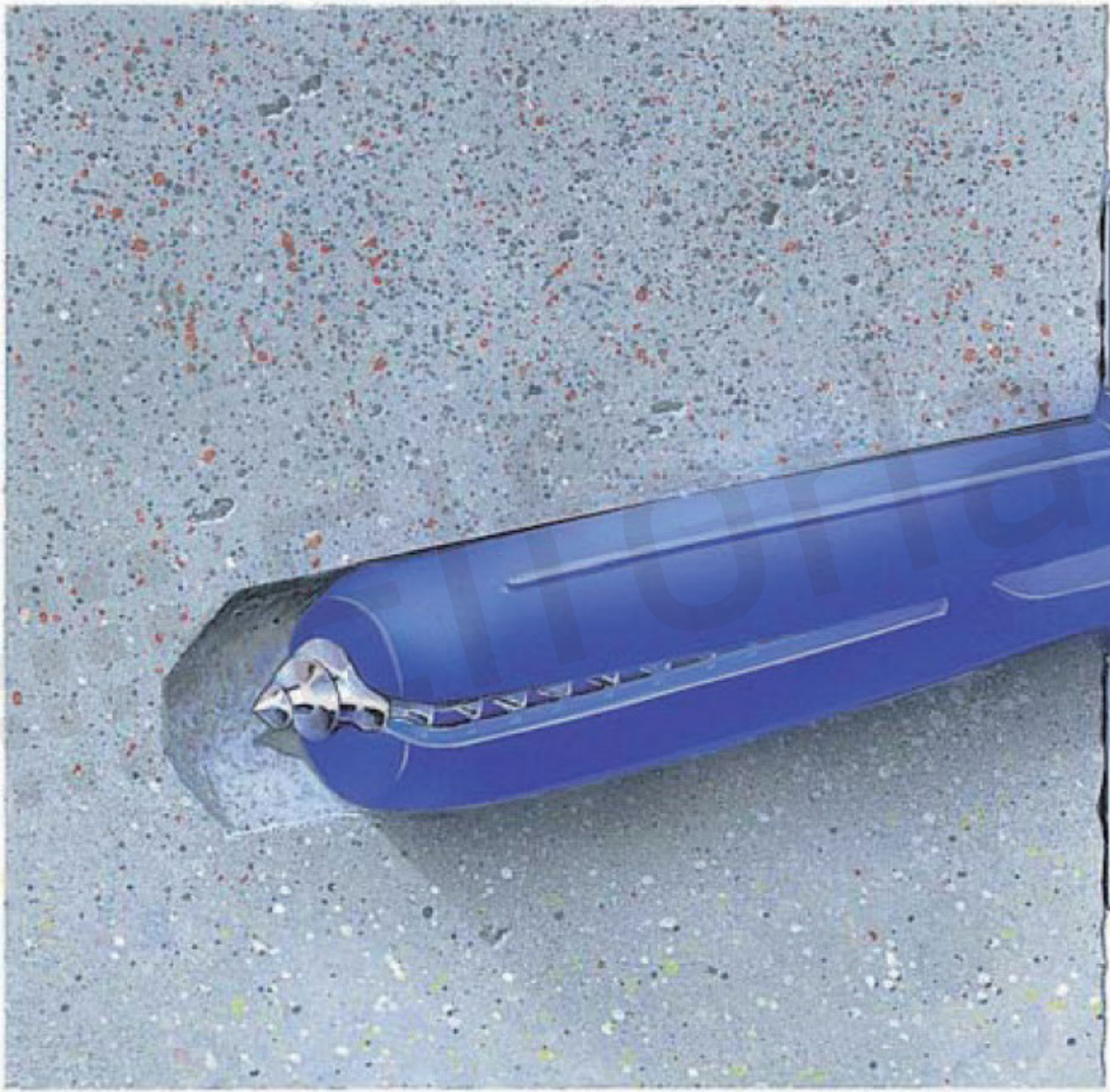

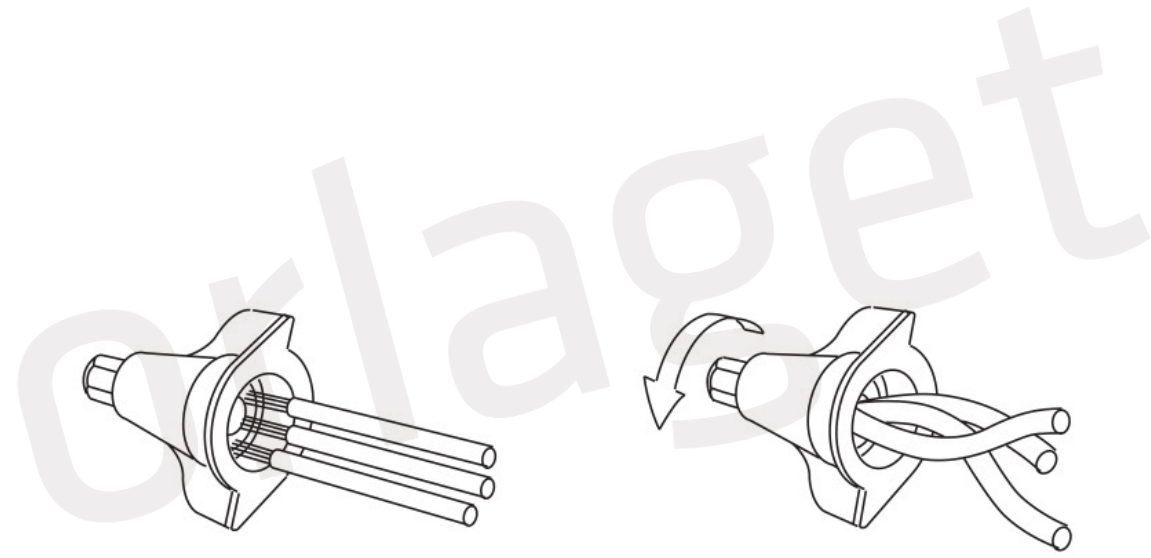
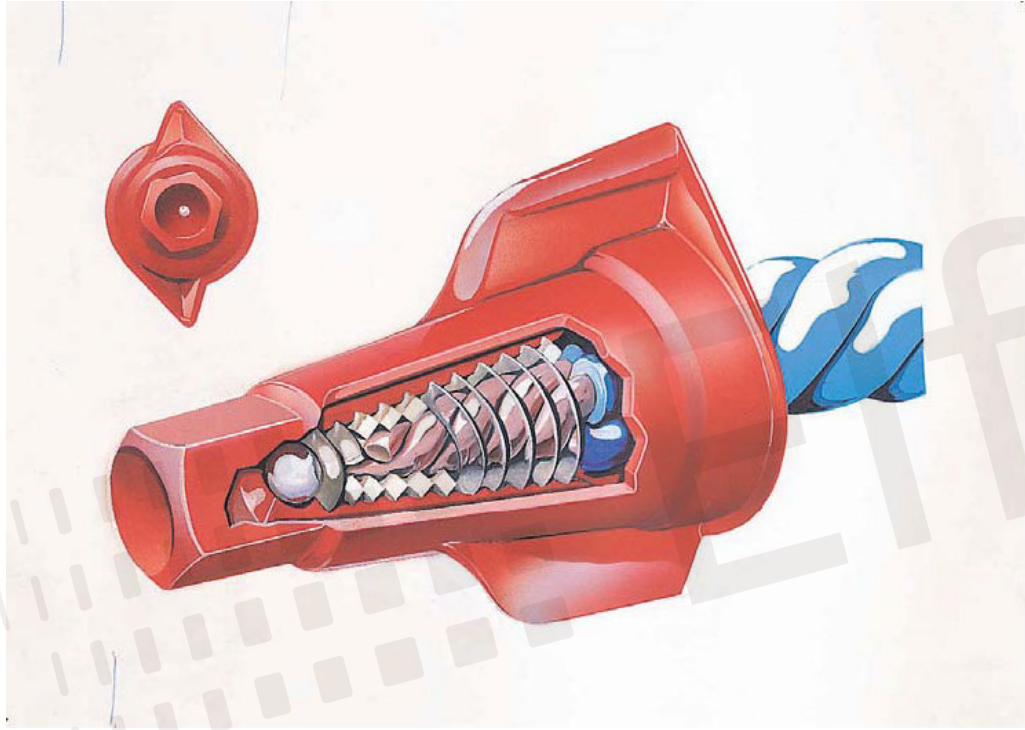





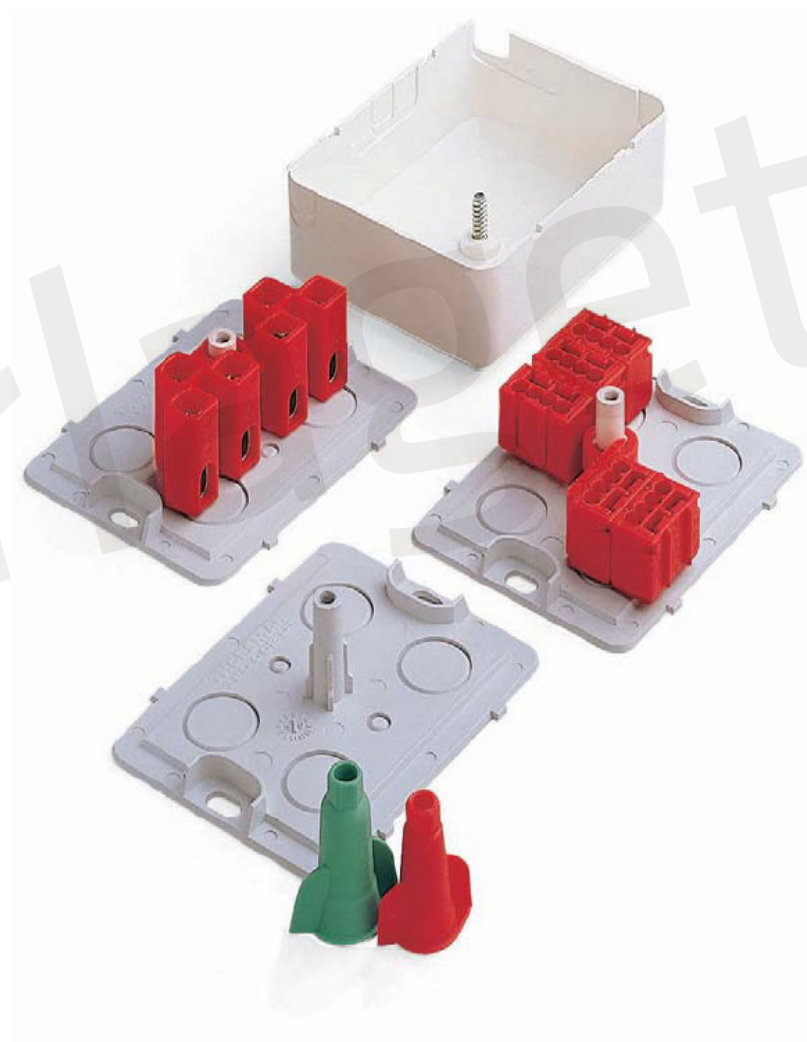
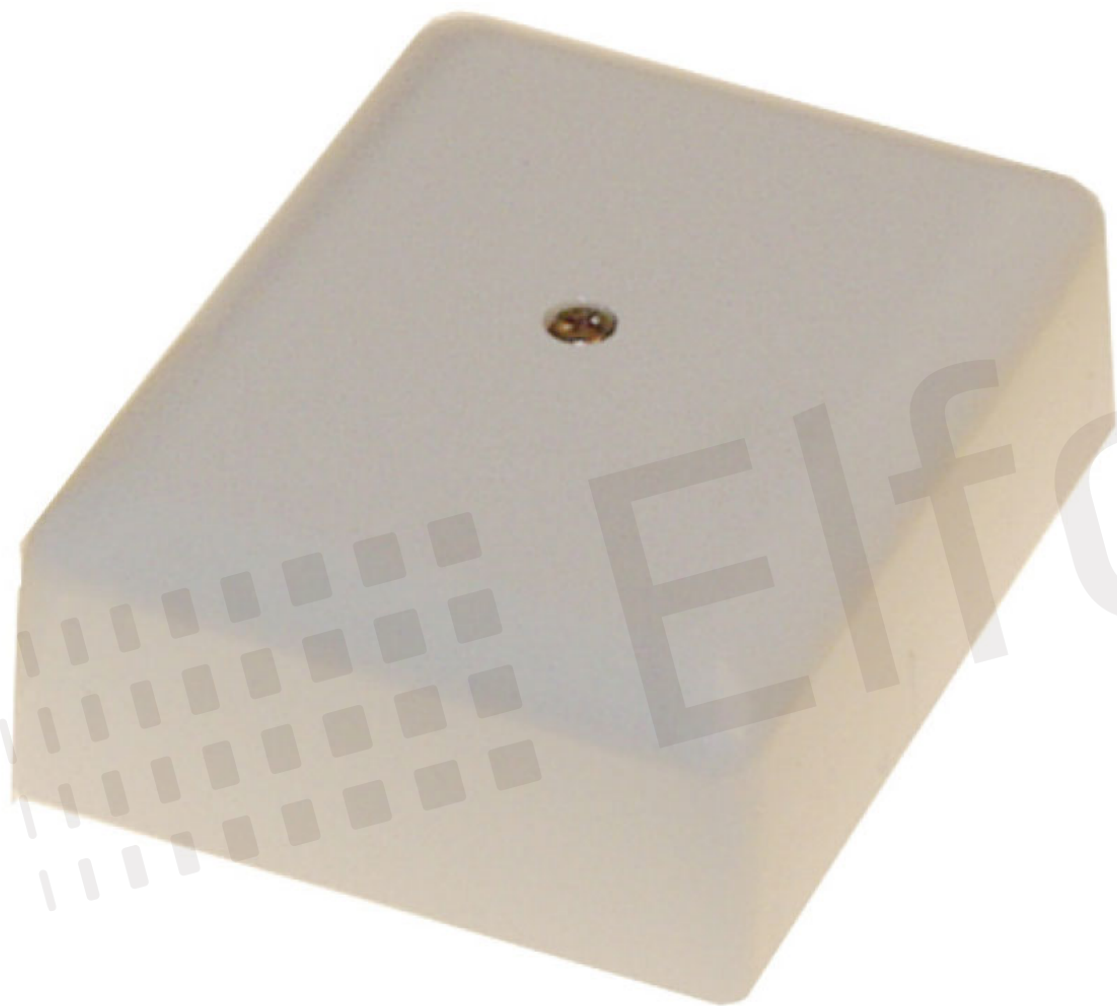

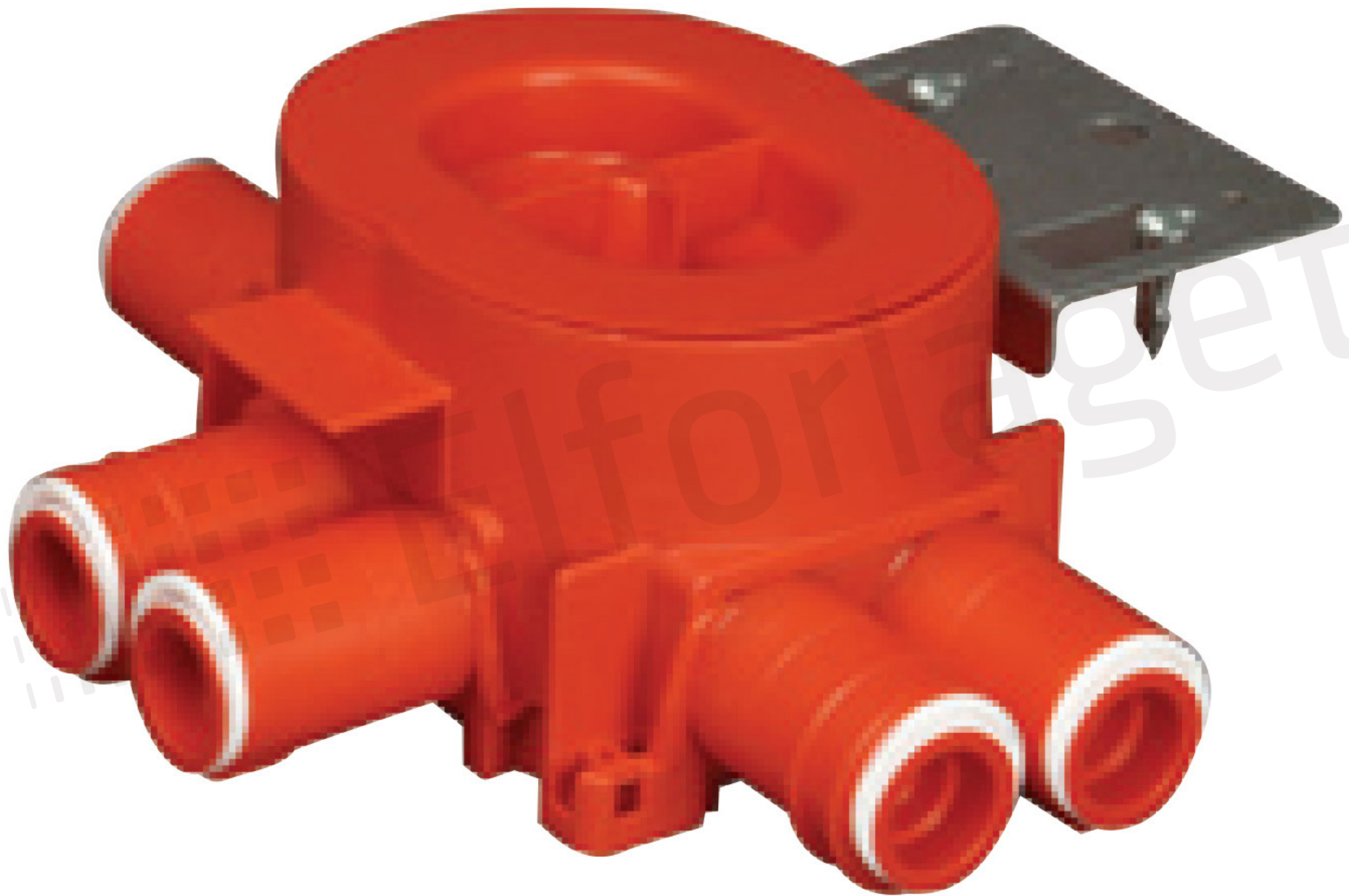











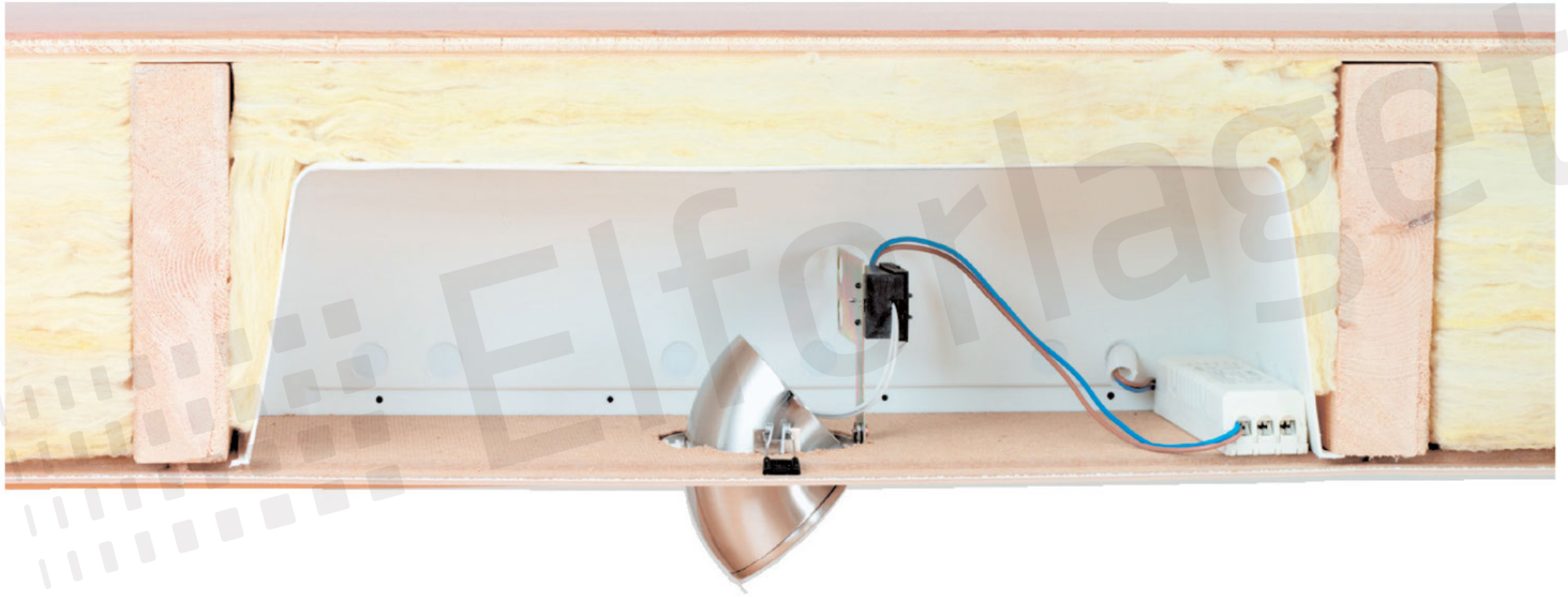









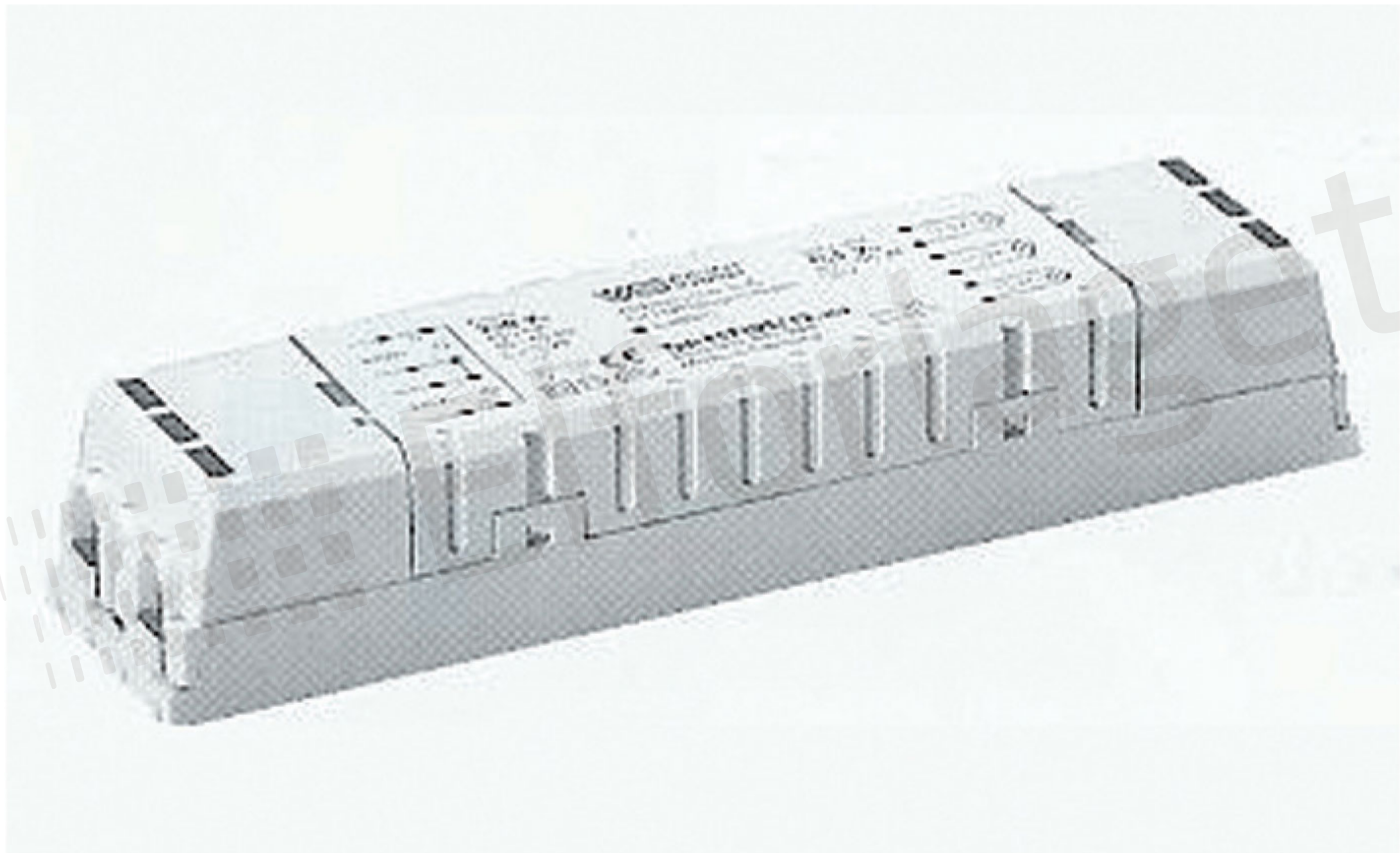





Elförlaget



